

Ventilation

Why is Ventilation Important?

While it should be one of the first appliances to think about, it's often times the last. Proper ventilation is critical for your kitchen for a number of reasons. Having good ventilation helps to remove the by-products from cooking such as heat, odor, grease, gas, steam and smoke.

Ventilation might sound exhausting, but at Bosch we make it simple!

Pairing and Buying Guides

We test **ALL** of our Ventilation with **ALL** of cooking surfaces

To ensure the **BEST** possible pairing

Removing the guess work for **YOU!**

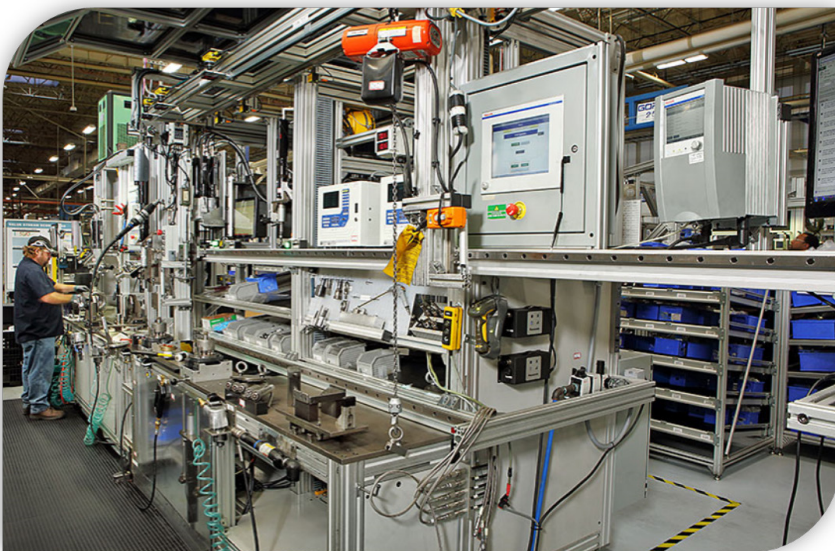

Above: An Inside Look of the BSH Ventilation Testing Center in LaFollette, TN

Right: Using Text4Specs, text “Vent” and get sent to Bosch’s Ventilation Buying Guide

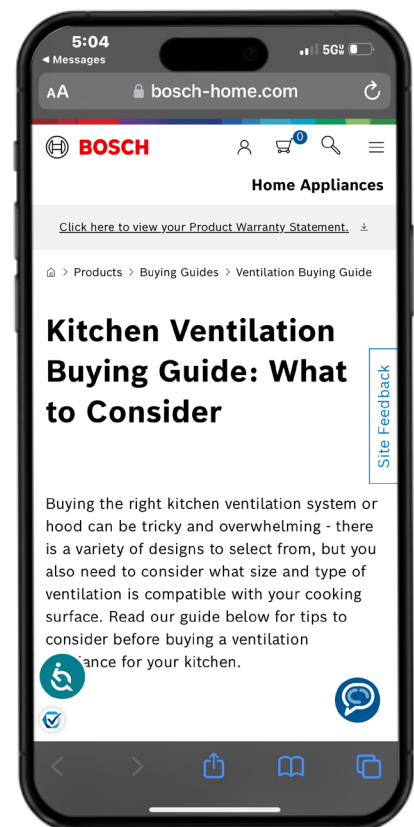

Downdraft Ventilation

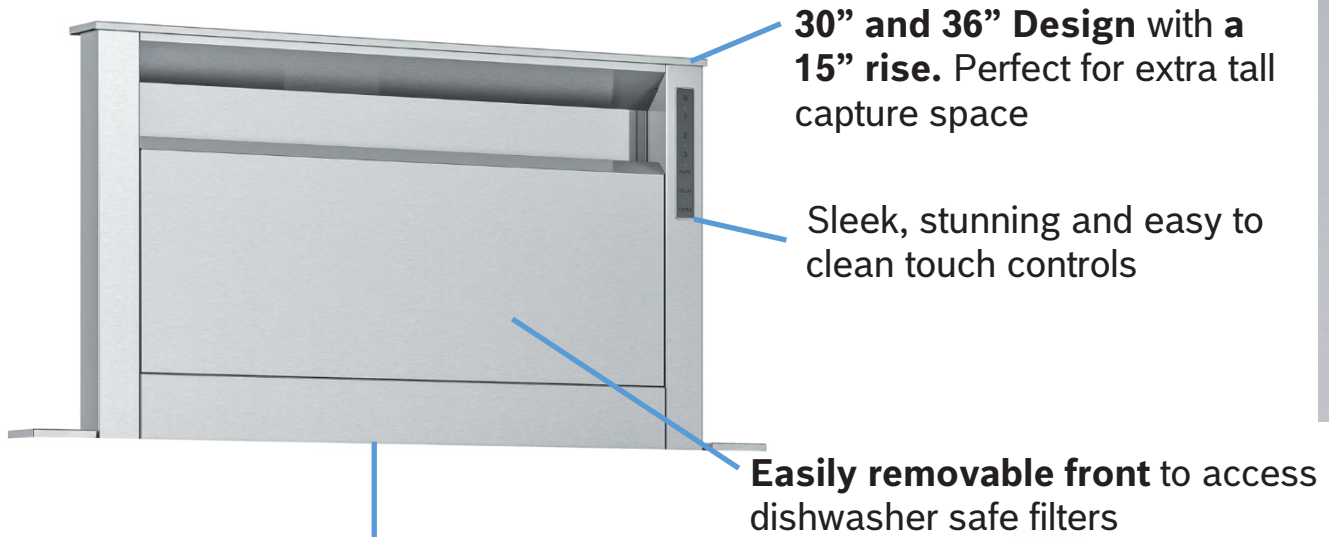

30" and 36" Design with a 15" rise. Perfect for extra tall capture space

Sleek, stunning and easy to clean touch controls

Easily removable front to access dishwasher safe filters

Pairs with **ALL** 30" and 36" Bosch gas, electric and induction cooktops **AND** Bosch Gas Rangetops!



Key Installation Reminders

Flexible Blower

Also referred to as an internal blower, **Bosch's flexible blower can be positioned 6 different ways** for a variety of installations



Inline/Remote Blower

Bosch also offers inline or remote blower for different venting options. **Remember to sell EXTNCB25W for a 25' cable** to connect the blower and hood together



Gas Cooktop Seal Kit

If you sell a Bosch gas cooktop, it is approved to do so. **PLEASE remember to sell the seal kit #HDD0/6RSP** as it is **REQUIRED** for installation



Recirculation

Downdrafts are approved with recirculation kits for electric/induction cooktops. They are **NOT APPROVED** for recirculation with gas cooktops. They **MUST** be vented.



Ventilation w/Home Connect®

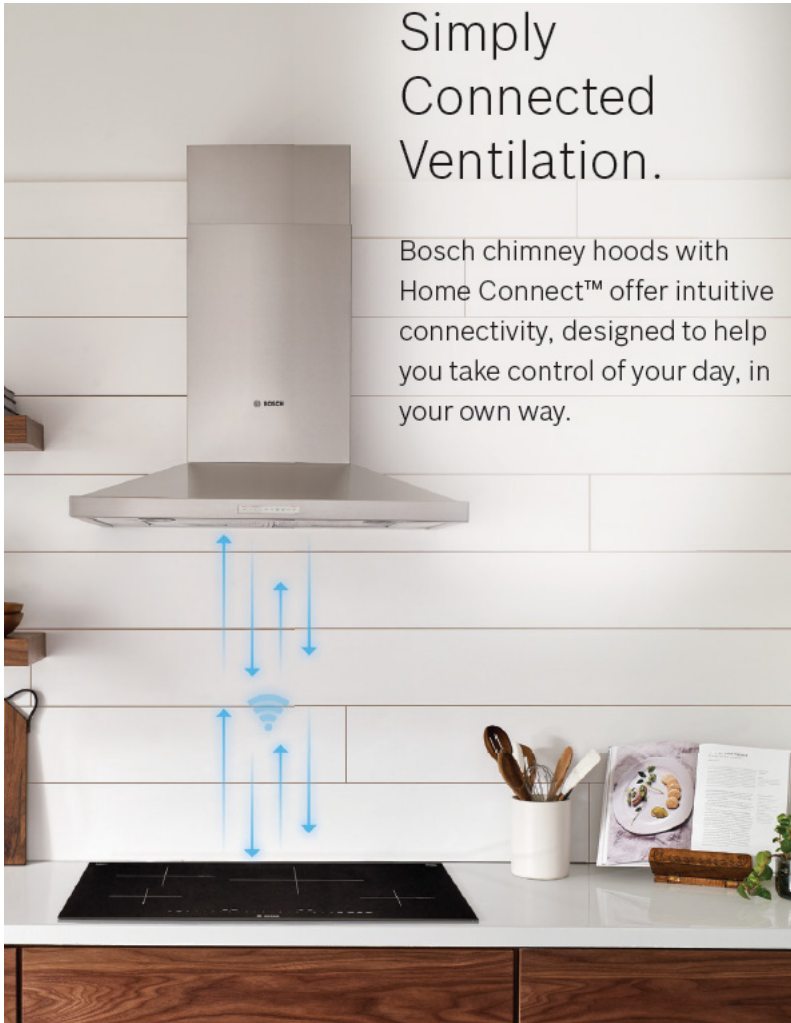

Simply
Connected
Ventilation.

Bosch chimney hoods with Home Connect™ offer intuitive connectivity, designed to help you take control of your day, in your own way.

Cooktop Hood Sync

Never forget to turn on your hood again! This allows your hood to automatically turn on when your cooktop turns on.

Voice Control

Connect with Google or Alexa. Ask them to turn on/off the hood, turn on/off the lights and more for the convenience of a hands-free operation.

Custom Settings/Notifications

Get alerts when it's time to clean your filter or change your charcoal filter (for recirculating models). You can personalize settings like lighting, fan speeds and timers.

Enhanced Customer Support

On Home Connect® you can find your model and serial numbers already loaded. Get customer support with ultimate peace of mind.

Select an Induction Cooktop with Home Connect®

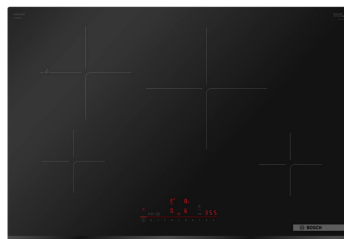

(24" Model - 800 Series) (30" Models - 500/800/Benchmark™) (36" Models - 500/800/Benchmark™)

Selection Ventilation with Home Connect®

Under Cabinet:

- DUH80553UC
- DUH86553UC
- DUHP0853UC
- DUHP6853UC

Custom Insert:







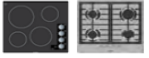

- HUI34253UC
- HUI30253UC
- HUI36253UC
- HUI80553UC
- HUI86553UC

Pyramid:

- HCP50652UC
- HCP56652UC

Bosch Ventilation Selection Guide

BLUE - Perfect Match
GREY - Viable Match

	Cooktops				Cooktops	Rangetops	Slide-In Ranges	Industrial Style Ranges	
									
	24-Inch Electric, Induction & Gas	30-Inch Electric & Induction	36-Inch Electric & Induction	30-Inch Gas	36-Inch Gas	36-Inch Gas	Electric, Induction, Gas & Dual-Fuel	30-Inch Induction, Gas & Dual-Fuel	36-Inch Induction, Gas & Dual-Fuel

Chimney Wall Hoods

	24-Inch HCP34E52UC	✓							
	30-Inch HCP30E52UC	✓	✓		✓		✓	✓	
	30-Inch HCP50652UC		✓		✓		✓	✓	
	30-Inch HCP80641UC		✓		✓		✓	✓	
	30-Inch HCB50651UC		✓		✓		✓	✓	
	36-Inch HCG56651UC		✓	✓	✓	✓	✓	✓	✓
	36-Inch HCP36E52UC		✓	✓	✓	✓	✓	✓	✓
	36-Inch HCP56652UC		✓	✓	✓	✓	✓	✓	✓
	36-Inch HCB56651UC		✓	✓	✓	✓	✓	✓	✓
	36-Inch HCP86641UC		✓	✓	✓	✓	✓	✓	✓

Under-Cabinet Range Hoods

	30-Inch DUH30253UC	✓	✓		✓		✓		
	30-Inch DUH50353UC		✓		✓		✓	✓	
	30-Inch DUH80553UC		✓		✓		✓	✓	
	30-Inch DUHP0853UC		✓		✓		✓	✓	
	36-Inch DUH36253UC		✓	✓	✓	✓	✓	✓	✓
	36-Inch DUH56353UC		✓	✓	✓	✓	✓	✓	✓
	36-Inch DUH86553UC		✓	✓	✓	✓	✓	✓	✓
	36-Inch DUHP6853UC		✓	✓	✓	✓	✓	✓	✓

Island Hood

	42-Inch HIB82651UC		✓	✓	✓	✓	✓	✓	✓
--	--------------------	--	---	---	---	---	---	---	---

Custom Insert Hoods

	24-Inch HUI34253UC	✓							
	30-Inch HUI30253UC	✓	✓		✓		✓	✓	
	30-Inch HUI80553UC	✓	✓		✓		✓	✓	
	36-Inch HUI36253UC			✓		✓			✓
	36-Inch HUI86553UC			✓		✓			✓

Downdrafts

	30-Inch HDD80052UC		✓		✓				
	36-Inch HDD86052UC			✓		✓	✓		

Pull-Out Hoods

	24-Inch HUI54452UC	✓							
	30-Inch HUI50351UC	✓	✓		✓		✓	✓	
	36-Inch HUI56551UC		✓	✓	✓	✓	✓	✓	✓

Be sure to text the word "Vent" to 21432 to get the most up to date Ventilation Pairing Guide with Text4Specs!



Under-Cabinet Hoods

300 Series

DUH30523UC - 30"
DUH36253UC - 36"

500 Series

DUH50353UC - 30"
DUH56353UC - 36"

800 Series

DUH80553UC - 30"
DUH86553UC - 36"

Benchmark™

DUHP0853UC - 30"
DUHP6853UC - 36"



- 300 CFM integrated blower
- Three (3) Power levels
- Dishwasher safe filters
- LED lighting
- Rotary knobs
- 5" height and 21" depth
- Recirculation kit available



- + Touch Controls w/Backlite LED



- + 600 CFM integrated blower
- + Four (4) Power levels
- + 11" height and 23" depth
- + Home Connect®



- + 800 CFM integrated blower
- + 18" height and 23" depth

Pyramid Chimney Wall Hoods

300 Series

HCP34E52UC - 24"
HCP30E52UC - 30"
HCP36E52UC - 36"

500 Series

HCP50652UC - 30"
HCP56652UC - 36"

800 Series

HCP80641UC - 30"
HCP86641UC - 36"



- 300 CFM integrated blower
- Three (3) Power levels
- Dishwasher safe filters
- 2 LED lights
- Controls with Red LCD Display
- Energy Star™ Certified
- Auto heat sensing blower
- Recirculation kit available



- + 600 CFM integrated blower
- + Four (4) Power levels
- + LED Touch Control panel
- + Home Connect® w/Cooktop-Hood Control
- NOT Energy Star™ Certified



- + Black Stainless Steel Finish
- + 2 Halogen Lights
- + Controls with Red LCD Display
- NO Home Connect®

Pyramid Chimney Wall Hoods

Box Island Hood

HIB82651UC - 42"

Box Wall Hood

HCB50651UC - 30"

HCB56651UC - 36"

Glass Canopy Wall Hood

HCG56651UC - 36"



- 600 CFM integrated blower
- Four (4) Power levels
- Dishwasher safe filters with stainless steel covers
- Halogen lights
- Auto heat sensing blower
- Recirculation kit available

800 Series



- 600 CFM integrated blower
- Four (4) Power levels
- Dishwasher safe filters with stainless steel covers
- Halogen lights
- Auto heat sensing blower
- Recirculation kit available

500 Series



+ Glass canopy design

Benchmark™

Specialty Hoods

Downdraft

HDD80052UC - 30"
HDD86052UC - 36"

Visor Hood

HUI54452UC - 24"
HUI50351UC - 30"
HUI56551UC - 30"

Custom Insert

HUI3_253UC - 300 Series
HUI8_553UC - 800 Series



- 3 blower options available (sold separately)
- 6 exhaust options available
- Three (3) power levels
- Dishwasher safe filters
- 15" Telescopic rise
- Sleek Touch Control Panel
- Recirculation kit available
- Gas Cooktop Seal Kit (sold separately and needed for use with gas cooktops)

Blower Options

- 600 CFM Flexible Blower - DHG602DUC
- 600 CFM Inline Blower - DHI1FZUC
- 600 CFM Remote Blower - DHR1FZUC

If inline or remote blower is sold, you must include accessory 25' EXTNCB25W. Cannot be combined



- 300 CFM integrated blower (30" unit)
- 500 CFM integrated blower (36" unit)
- Three (3) Power levels
- Dishwasher safe filters
- Halogen lighting
- Slide switch control
- Recirculation kit available

24" Unit Only

- 400 CFM integrated blower
- Four (4) power levels
- Touch controls
- 2 LED lights



- Four (4) Power levels
- Dishwasher safe filters
- Touch Controls
- 2 LED Lights
- Home Connect® with Cooktop-Hood Control

300 Series

- 24" / 30" / 36" models
- 300 CFM integrated blower
- 6" ducting

800 Series

- 30" / 36" models
- 600 CFM integrated blower
- 8" ducting