

36" Undercabinet Hood

800 Series – Stainless Steel DPH36652UC



DPH36652UC
Stainless Steel

Quickly and quietly clears the air of smoke and odors.

Features & Benefits

An impressive extraction rate of 600 CFM ensures this hood will have your kitchen odor free in no time.

Allows you to adjust the performance of your hood to match the type of cooking.

Efficiently filters grease and other solid particles out of the extracted air.

Flexible design gives the ability to recirculate the air back into the kitchen.

Professional styling with deep capture area.

General Properties

Operating mode	Convertible: ducted / recirculating
Maximum CFM	600 CFM
Number of speed settings	2-stage
Motor location	Integrated motor in hood body
Number of lights	2
Bulb type	Incandescent
Total power of the lamps (W)	80 W
Damper included	Yes
Grease filter material	Aluminum
Grease filter type	Multilayer cassette

Technical Details

Watts (W)	253 W
Volts (V)	120 V
Frequency (Hz)	60 Hz
Plug type	No plug



Dimensions & Weight

Overall appliance dimensions (width of canopy included) (HxWxD) (in.)	11" x 36" x 23"
Required distance above cooktop/range cooking surface	30" Electric / 30" Gas
Diameter of air duct (in.) top	8"
Diameter of air duct (in.) back	8"
Net weight (lbs)	34 lbs

Accessories—Optional

Replacement charcoal filter	DHZ3052UC
Recirculation kit	DRZ3652UC

For help and assistance with Bosch accessories please visit: www.bosch-eshop.com/eshop/bosch/us or call 1-800-944-2904 Mon-Fri 5am to 6pm PST Sat 6am to 3pm PST

Notes: All height, width and depth dimensions are shown in inches. BSH reserves the absolute and unrestricted right to change product materials and specifications, at any time, without notice. Consult the product's installation instructions for final dimensional data and other details prior to making cutout. Applicable product warranty can be found in accompanying product literature or you may contact your account manager for further details.

Warranties: Bosch warrants that the Product is free from defects in materials and workmanship for a period of three hundred and sixty-five (365) days from the date of purchase. The foregoing timeline begins to run upon the date of purchase, and shall not be stalled, tolled, extended, or suspended, for any reason whatsoever. This Product is also warranted to be free from cosmetic defects in material and workmanship (such as scratches of stainless steel, paint/porcelain blemishes, chip, dents, or other damage) to the finish of the Product, for a period of thirty (30) days from the date of purchase or closing date for new construction. This cosmetic warranty excludes slight color variations due to inherent differences in painted and porcelain parts, as well as differences caused by kitchen lighting, product location, or other similar factors. This cosmetic warranty specifically excludes any display, floor, "As Is", or "B" stock appliances.

For more information on our entire line of products, go to www.bosch-home.com/us or call 1-800-944-2904

© BSH Home Appliances Corporation. All rights reserved. Bosch is a registered trademark of Robert Bosch GmbH.

09/15

36" Undercabinet Hood

800 Series – Stainless Steel DPH36652UC



Installation Details

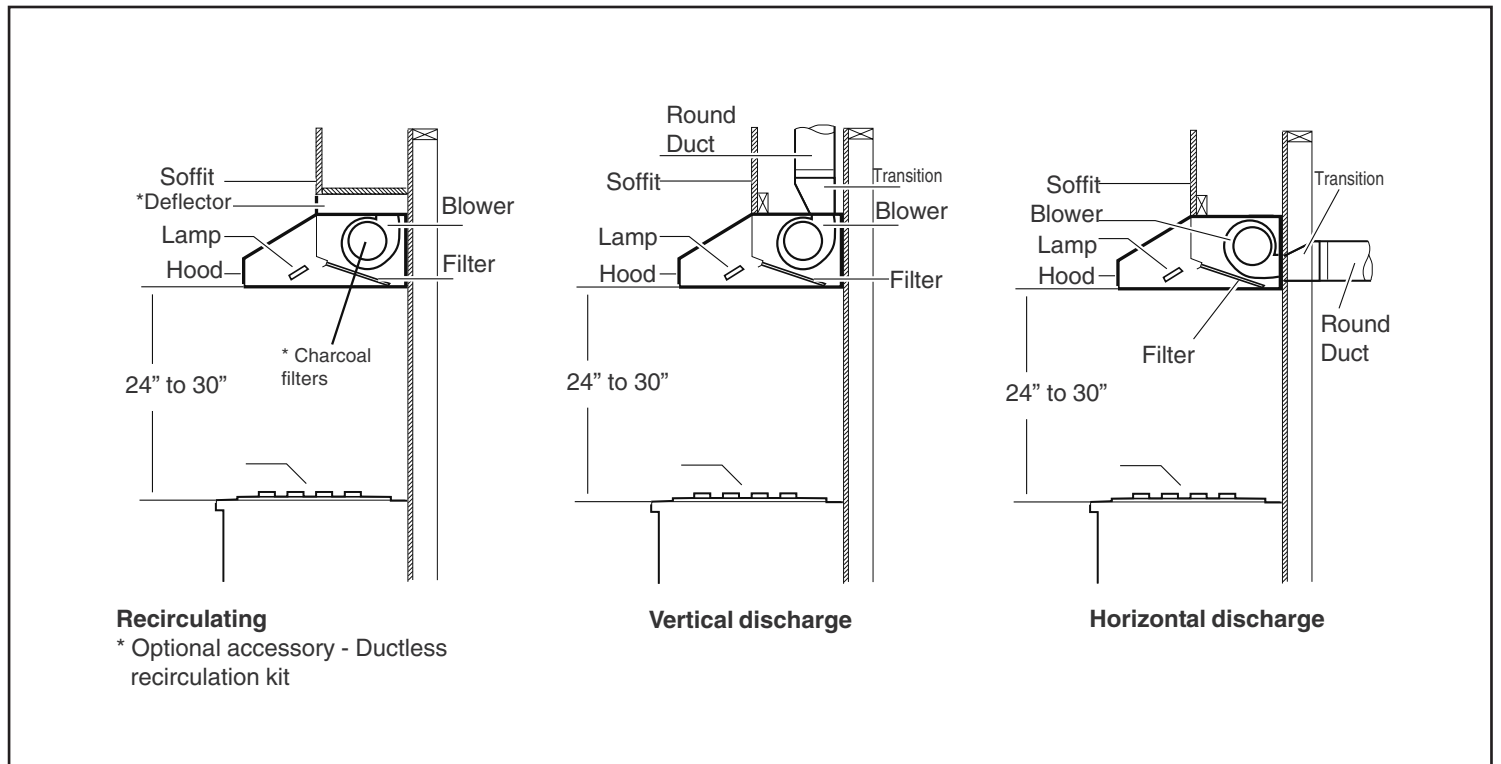
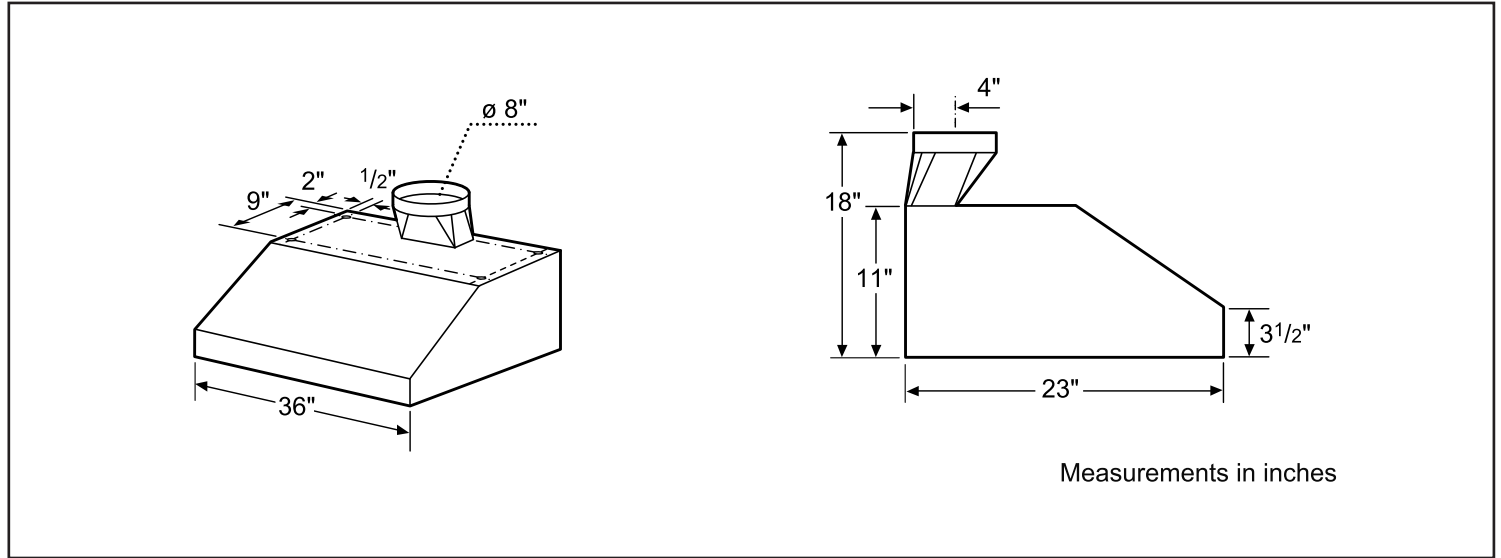

For help and assistance with Bosch accessories please visit: www.bosch-eshop.com/eshop/bosch/us or call 1-800-944-2904 Mon-Fri 5am to 6pm PST Sat 6am to 3pm PST

Notes: All height, width and depth dimensions are shown in inches. BSH reserves the absolute and unrestricted right to change product materials and specifications, at any time, without notice. Consult the product's installation instructions for final dimensional data and other details prior to making cutout. Applicable product warranty can be found in accompanying product literature or you may contact your account manager for further details.

Warranties: Bosch warrants that the Product is free from defects in materials and workmanship for a period of three hundred and sixty-five (365) days from the date of purchase. The foregoing timeline begins to run upon the date of purchase, and shall not be stalled, tolled, extended, or suspended, for any reason whatsoever. This Product is also warranted to be free from cosmetic defects in material and workmanship (such as scratches of stainless steel, paint/porcelain blemishes, chip, dents, or other damage) to the finish of the Product, for a period of thirty (30) days from the date of purchase or closing date for new construction. This cosmetic warranty excludes slight color variations due to inherent differences in painted and porcelain parts, as well as differences caused by kitchen lighting, product location, or other similar factors. This cosmetic warranty specifically excludes any display, floor, "As Is", or "B" stock appliances.

For more information on our entire line of products, go to www.bosch-home.com/us or call 1-800-944-2904

© BSH Home Appliances Corporation. All rights reserved. Bosch is a registered trademark of Robert Bosch GmbH.

09/15