

36" Pyramid Canopy Chimney Hood

300 Series – Stainless Steel HCP36651UC



HCP36651UC
Stainless Steel

Wall mounted chimney hoods add style and sophistication to the kitchen and gives you greater freedom in your kitchen planning.

Features & Benefits

Touch controls with LCD display.

600 CFM centrifugal integrated blower included.

Four speed touch controls with LCD display.

Dishwasher safe aluminum mesh filters.

Converts to recirculation mode with accessory kit (separate purchase required).

General Properties

Operating mode	Convertible: ducted / recirculating
Maximum CFM	600 CFM
Sones	9.9 HS / 4.56 WS
Number of speed settings	4-stage
Motor location	Integrated motor in hood chimney
Number of lights	2
Bulb type	Halogen
Total power of the lamps (W)	80 W
Damper included	Yes
Grease filter material	Aluminum
Grease filter type	Multilayer cassette

Technical Details

Volts (V)	120 V
Frequency (Hz)	60 Hz
Plug type	No plug



Dimensions & Weight

Overall appliance dimensions (width of canopy included) (HxWxD) (in.)	24 9/16" – 38 7/8" / 28 1/4" – 42 9/16" x 36" x 19 11/16"
Height of the chimney (in.)	19 9/16" – 33 7/8" / 23 1/4" – 42 9/16"
Required distance above cooktop/range cooking surface	24" Electric / 30" Gas
Diameter of air duct (in.) top	8"
Net weight (lbs)	53 lbs

Accessories—Optional



HCPEXT5UC
Chimney extension for 9-11.5 ft. ceilings

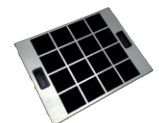

HCIFILTUC
Filter kit



HCREC5UC
Recirculation kit

For help and assistance with Bosch accessories please visit: www.bosch-eshop.com/eshop/bosch/us or call 1-800-944-2904 Mon-Fri 5am to 6pm PST Sat 6am to 3pm PST

Notes: All height, width and depth dimensions are shown in inches. BSH reserves the absolute and unrestricted right to change product materials and specifications, at any time, without notice. Consult the product's installation instructions for final dimensional data and other details prior to making cutout. Applicable product warranty can be found in accompanying product literature or you may contact your account manager for further details.

Warranties: Bosch warrants that the Product is free from defects in materials and workmanship for a period of three hundred and sixty-five (365) days from the date of purchase. The foregoing timeline begins to run upon the date of purchase, and shall not be stalled, tolled, extended, or suspended, for any reason whatsoever. This Product is also warranted to be free from cosmetic defects in material and workmanship (such as scratches of stainless steel, paint/porcelain blemishes, chip, dents, or other damage) to the finish of the Product, for a period of thirty (30) days from the date of purchase or closing date for new construction. This cosmetic warranty excludes slight color variations due to inherent differences in painted and porcelain parts, as well as differences caused by kitchen lighting, product location, or other similar factors. This cosmetic warranty specifically excludes any display, floor, "As Is", or "B" stock appliances.

For more information on our entire line of products, go to www.bosch-home.com/us or call 1-800-944-2904

© BSH Home Appliances Corporation. All rights reserved. Bosch is a registered trademark of Robert Bosch GmbH.

09/15

36" Pyramid Canopy Chimney Hood

300 Series – Stainless Steel HCP36651UC



Installation Details

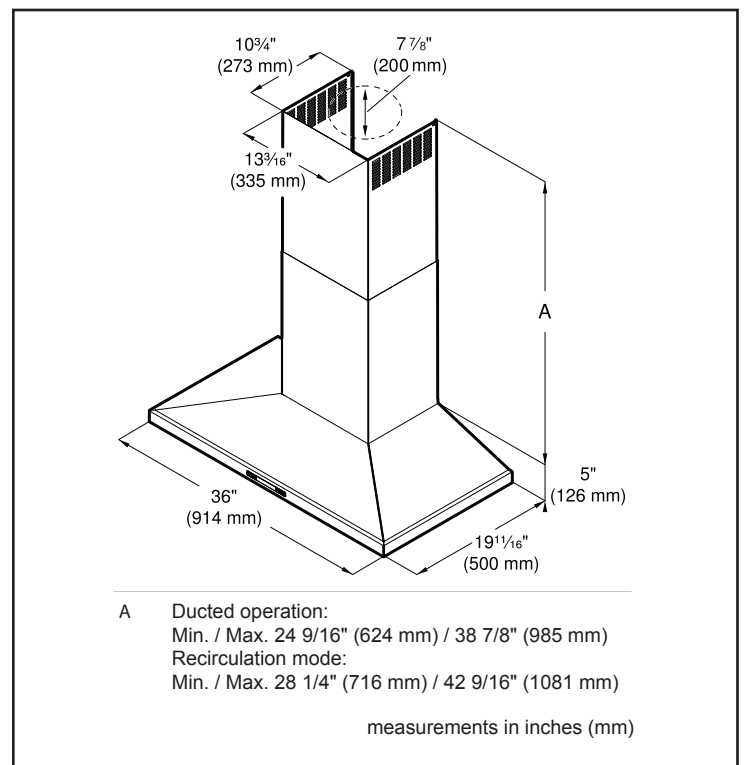
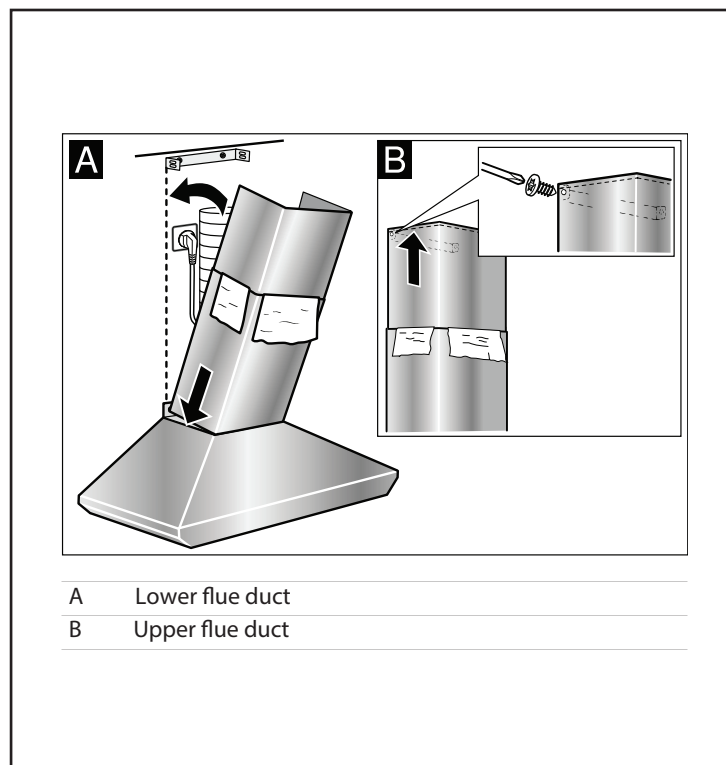
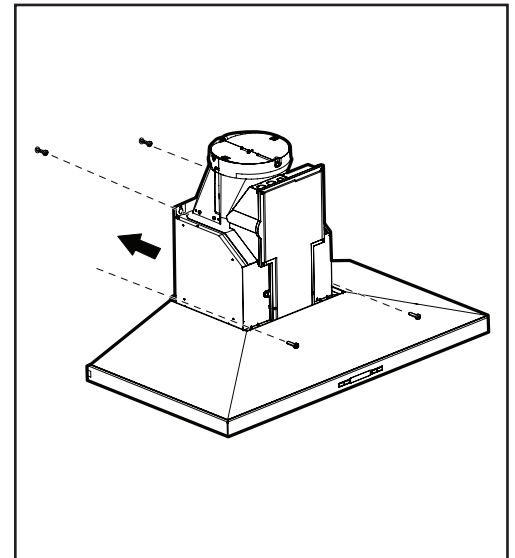
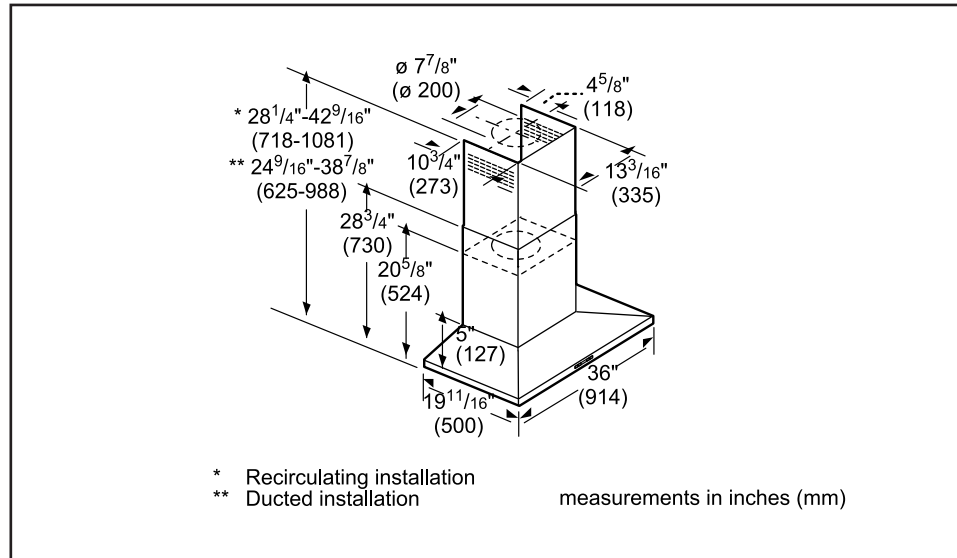

For help and assistance with Bosch accessories please visit: www.bosch-eshop.com/eshop/bosch/us or call 1-800-944-2904 Mon-Fri 5am to 6pm PST Sat 6am to 3pm PST

Notes: All height, width and depth dimensions are shown in inches. BSH reserves the absolute and unrestricted right to change product materials and specifications, at any time, without notice. Consult the product's installation instructions for final dimensional data and other details prior to making cutout. Applicable product warranty can be found in accompanying product literature or you may contact your account manager for further details.

Warranties: Bosch warrants that the Product is free from defects in materials and workmanship for a period of three hundred and sixty-five (365) days from the date of purchase. The foregoing timeline begins to run upon the date of purchase, and shall not be stalled, tolled, extended, or suspended, for any reason whatsoever. This Product is also warranted to be free from cosmetic defects in material and workmanship (such as scratches of stainless steel, paint/porcelain blemishes, chip, dents, or other damage) to the finish of the Product, for a period of thirty (30) days from the date of purchase or closing date for new construction. This cosmetic warranty excludes slight color variations due to inherent differences in painted and porcelain parts, as well as differences caused by kitchen lighting, product location, or other similar factors. This cosmetic warranty specifically excludes any display, floor, "As Is", or "B" stock appliances.

For more information on our entire line of products, go to www.bosch-home.com/us or call 1-800-944-2904

© BSH Home Appliances Corporation. All rights reserved. Bosch is a registered trademark of Robert Bosch GmbH.